

# E-Beam Hard Disk Drive Using Gated Carbon Nano Tube Source and Phase Change Media

William S. Oakley  
NanoScale Storage Systems, Inc  
willoakley1@earthlink.net

## Abstract

A novel high speed, high capacity electron-beam recording technique using nano technology in a Hard Disk Drive form factor is described. The e-beam source is a carbon nanotube (CNT) emitter and can be gated at rates up to several gigahertz. The planned recording media is Phase Change with sub-nanosecond response times, and data read-out by Secondary Electron Emission is anticipated. The key parameters for generating the recording beam are described and a preliminary design is discussed in which the CNT based Read/Write head replaces the magnetic head in a standard Hard Disk Drive (HDD). The technique sidesteps limits associated with HDD technology and potentially provides far higher recording densities and higher data rates than possible with conventional magnetic-recording. The NS3 NanoTech Disk (NTD) approach may provide a path forward for HDD's to the low nanometer mark scale.

## 1. Introduction:

An approach to high performance data recording is discussed that provides nanoscale digital electron beam recording onto rotating disc media using a gated Carbon NanoTube (CNT) as a miniature precision electron-beam emitting source. With the ability to record marks in the low nanometer range and to achieve gigahertz modulation bandwidths per channel, this technology may provide a future upgrade path for Hard Disc Drives. In addition, the Nano Technology Disk (NTD) approach allows other options not readily available with magnetic technology, such as dense arrays of Read/Write heads and high performance archival HDD's employing different media.

NS3's goal is to demonstrate performance beyond that achievable with magnetic technology by showing digital data recording with sub 30nm, mark size and a platter capacity greater than 500 GB per square inch, (>1TB per 120 mm diameter, >350GB per 3.5 inch platter), and read/write rates of 100 Megabytes per second or greater. Future performance limits are

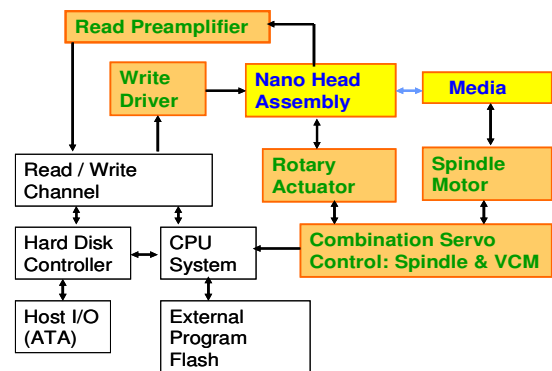
probably far in excess of these initial goals as mark sizes of a few nanometers should eventually be possible. A secondary goal is to provide mass data storage with true archival properties in addition to re-writable media. Media constraints are also diminished as with a beam technology the head fly height can be much larger than in today's HDD's.

The basic approach is to adapt the existing hard disk drive technology shown in **Figure 1** and obtain a major upgrade in performance by replacing the magnetic Read/Write (R/W) head at the end of the actuator arm with a CNT based NanoHead Assembly (NHA).



**Figure 1. Typical Multi platter Hard Disk Drive**

A typical HDD configuration is shown in **Figure 2**. Functions employing the new technology are shown in yellow, elements in the white boxes are unchanged. Those in tan boxes use standard technology but will need updating to match the increased performance of the CNT based NanoTech Drive. Spindle motors are unchanged for a given data rate at the same bits per inch linear density, but smaller bits provide increased capacity and require slower disk rotation speeds.



**Figure 2. Typical Disk Drive Configuration.**

**Table 1** shows the potential platter data capacity with the NanoDrive technology as a function of mark size for two standard platter diameters.

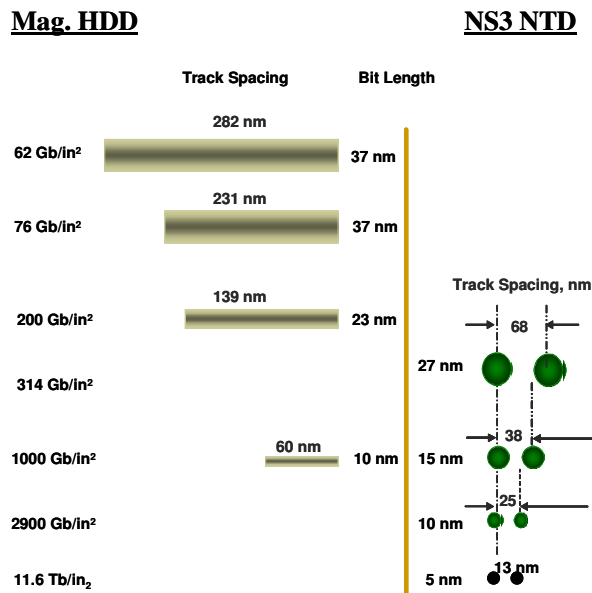
One advantage of a beam technology over magnetics is that the e-beam can be focused at a distance from the Read/Write head and consequently the recorded mark size is independent of the head size and fly height.

**Table 1. Platter Capacity in Terabytes, vs. Mark length and Platter Diameter**

Mark length, nm	27	19	13.5	9.5	6.8	4.8
120 mm	1.0	2.0	4.0	8.0	16.0	32.0
3.5 inch	0.55	1.1	2.2	4.4	8.8	17.6

**Table 2** shows the relative track widths for magnetic vs. e-beam R/W heads, initially with the same down track bit length, i.e. data rate. This provides an immediate increase in data capacity of about 5X without changing the disk rotation rate, spindle motor or most of the drive electronics. Essentially, as shown in Figure 2, only the write driver and detector circuitry need change.

**Table 2. Comparison of CNT mark size with standard magnetic recording.**



Carbon nanotube technology is relatively new but has advanced rapidly the design and fabrication of a read-write head is now viewed as a design development task. Implementing appropriate media entails some small risk as does achieving the desired track following accuracy. The use of a CNT based Nano Head Assembly enables several innovations not practical with today's HDD's.

These are possible as CNT emitters can be grown in close proximity to each other. Mark detection schemes rely on electron interaction with the media, an area of little data, but offering many media possibilities.

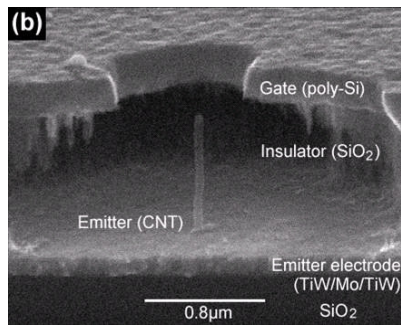
## 2. Electron Beam Recording

The art of recording analog or digital signal data by irradiating recording media with a focused e-beam and recording marks by thermal or electro-chemical means is well known and is widely used in some industries. Recording devices have been fabricated using a wide variety of media and have employed various means of generating a modulated e-beam, or a multiplicity of beams. In prior approaches the emitting source has been large compared to the desired recorded mark size requiring complex electron lenses and apertures to modify and focus the beam(s) onto the recording media. Further, these systems have invariably required the recording media and the e-beam source to be contained in the same vacuum so as to enable the electron beam to propagate through the system to the recording media without being substantially scattered by air molecules. Historical brightness values of  $2 \times 10^8 \text{ A.st}^{-1} \cdot \text{m}^{-2} \cdot \text{V}^{-1}$  have been achieved with e-beam currents of a few micro-amps and accelerated by a few tens of kilovolts, producing beam diameters in the micron range and limited by electron lens designs and emitted electron velocity spread. Current electron guns employ either a cold field emission gun or a Schottky emitter and result in e-gun assemblies far too large to be used in HDD's a requiring an actuator mounted emitter as in Figure 1.

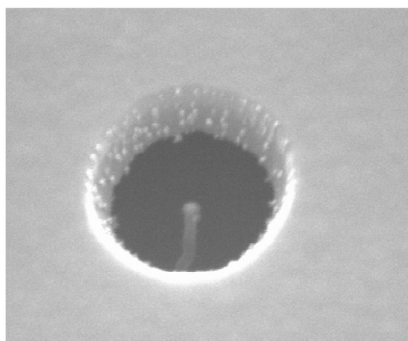
The usefulness of an electron source in recording depends of several main parameters that include both the energy and the energy spread of the emitted electrons and the source brightness. A CNT sourced e-beam has both a significantly smaller virtual source and brightness more than an order of magnitude greater than other sources, i.e. about  $3 \times 10^9 \text{ A.st}^{-1} \cdot \text{m}^{-2} \cdot \text{V}^{-1}$ . A multi-walled CNT diameter of about 30 nanometers is achievable and provides a small virtual source size, e.g. 20 nanometers. With a 50 volt potential the CNT tip emits up to 2 micro-amps that can be focused into a nearly collimated beam with a small range of electron velocities. Current is extracted by a voltage on an annular electrode about one micron from the CNT.

Extraction voltage modulation enables gating the emitted current at low gigahertz rates. The CNT fabrication process is straightforward, rapid and reliable, with gated CNT emitters grown essentially to specification in less than one hour in a wafer fabrication environment using only metallic electrodes and dielectric insulators: ion implantation is not required. The wafer approach leads to low cost devices via the "slice and dice" techniques. The process also facilitates fabrication of

arrays of CNT emitters. **Figure 3** and **Figure 4** show SEM photos of gated CNT emitters fabricated by Cambridge University (UK) for NS3.

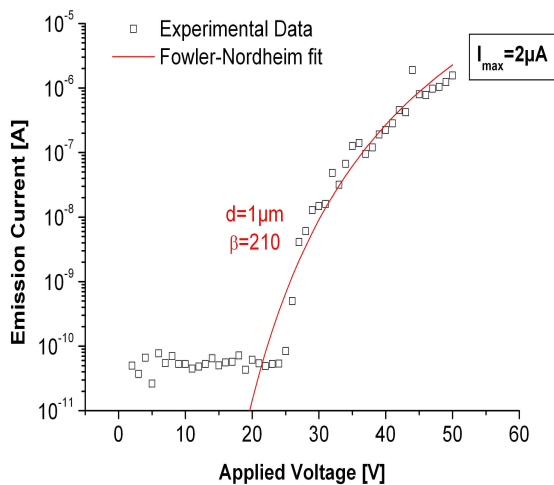


**Figure 3. CNT Emitter in Gated Cavity**



**Figure 4. SEM Photo of CNT Gated Emitter with 800nm Diameter Cavity.**

A typical emitted current vs. voltage curve obtained with the gated emitters is shown in **Figure 5**.



**Figure 5. CNT Emitter Current vs. Voltage**

### 3. Nanometer Scale Recording:

With beam (e.g. laser) recording the recorded mark size is directly dependent on the beam wavelength and mark sizes much less than one wavelength are not practical. Electron optics obeys essentially the same propagation and focusing laws as light, but electrons have equivalent wavelengths much smaller than the wavelength of visible light, enabling far smaller recorded mark sizes.

Limiting beam related factors in the design of a CNT e-beam recorder are expected to be the spherical aberration of electron lenses used in the NS3 nanohead. Electron Optics software is available from MEBS that permits accurate design and evaluation of emitter head designs. Preliminary software analysis shows FWHM beams of 30nm or less are achievable with simple NanoHead designs and the initial gated CNTs obtained by NS3 NanoHead fabrication issues relate to voltage isolation at small dimensions and the need to accurately center electrodes to minimize beam distortions.

### 4. Electron Wavelength

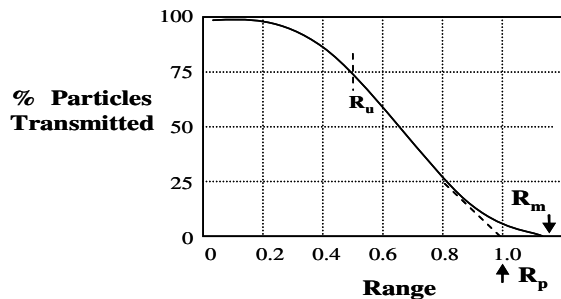
Focused beam sizes limited by the lens ‘f number’ and the beam wavelength, with spot diameters less than one wavelength difficult to achieve. E-beam wavelengths are very small compared to 400nm blue light. The kinetic energy imparted to an electron of electric charge  $e$  and mass  $m$  falling through a potential  $V$  to a velocity  $s$  is given by  $eV = (1/2) ms^2$ . The momentum of an electron is  $p = ms$ , so  $eV = p^2/2m$  and  $p = (2meV)^{1/2}$ . The equivalent wavelength of a particle of momentum  $p$  is given by  $\lambda = h/p$ , where  $h$  is Planck’s constant. Hence  $\lambda = h/(2meV)^{1/2}$ . Inserting known values for  $m$ ,  $e$ , and  $h$ , gives  $\lambda = 1.2/V^{1/2}$  where  $\lambda$  is in nanometers and  $V$  is in volts. For  $V=1kv$  the electron wavelength is 0.038nm, 11,000 times shorter than 420nm blue light.

### 5. Electron Beam Penetration

Previous E-beam writing systems have usually operated in vacuum as beam absorption in the path between the CNT and the media is an issue if a drive “flying head” approach is used at atmospheric pressure. A thin ‘window’ is required to protect the CNT emitter from oxidation, but a high fly height will allow most of the beam exiting a window to reach the media.

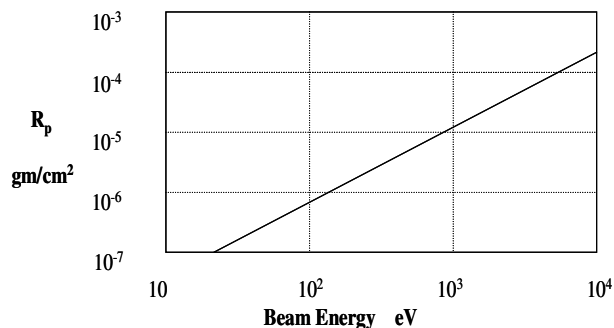
Penetration of low energy electron beams into a material depends on only the beam energy and the material density. Electrons will penetrate air to some small distance and will penetrate thin materials (membranes) which can act as windows. Each electron maintains its original energy until it collides with a molecule of the material. Hence the number of original

electrons decreases as the beam propagates into the material. **Figure 6** shows the relative loss of beam energy as a function of penetration distance for an electron beam where the extrapolated practical range is  $R_p$  and the maximum range is  $R_m$ . The useful range  $R_u$ , is taken to be where 75% of the beam energy is transmitted, at about 50% of the Practical Range  $R_p$ .



**Figure 6. Particle Transmission Ranges**

**Figure 7** shows the Practical Range  $R_p$ , as a function of absorber density and the beam energy and applies to essentially all materials of any density, e.g. air or metal. Dividing a value of  $R_p$  by a material density in  $\text{gms.cm}^3$  gives the range  $R_p$  in cm.



**Figure 7. Practical Range  $R_p$  vs. Beam Energy**

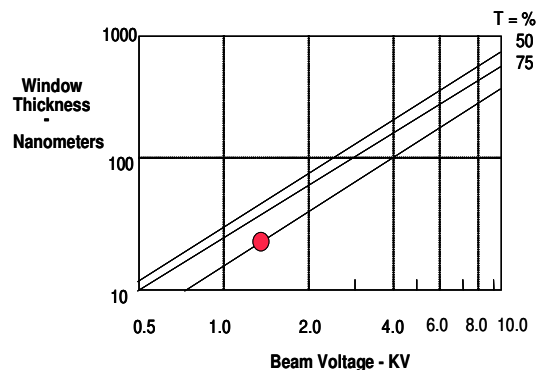
Figures 6 and Figure 7 are based on published data.

## 6. Electron Transmission in Air:

The Practical Range,  $R_p$ , for electrons of energy 1keV is shown in Figure 9 as about  $R_p = 1.2 \times 10^{-5} \text{ gm/cm}^2$ . The density of 300°K dry air is about  $1.2 \times 10^{-3} \text{ gm/cm}^3$ , thus the Practical Range in air is  $1.2 \times 10^{-5} / 1.2 \times 10^{-3} = 1 \times 10^{-2} \text{ cm.}$ , or 100 microns. From Figure 8 with  $R_p = 100 \text{ microns}$ , 75% of the electrons will remain unabsorbed after passing through about 50 microns. Reducing the air pressure by half will double the useful range, and doubling the electron energy will increase the useful range by slightly more than a factor of two.

## 7. Electron Permeable Membranes

Material absorption characteristics enable the penetration of electrons through a thin window to be estimated. A typical window material, Silicon Nitride, of density  $2.2 \text{ gm/cm}^3$ , has a thickness vs. electron energy relationship as in **Figure 8**. A window 0.025 micron (25nm) thick will pass 90% of a 1.5kV beam, although some limited scattering will occur. Beam scattering diminishes and transmission increases at higher beam voltages.



**Figure 8. Silicon Nitride Window, Transmission vs. Thickness & Beam Energy**

## 8. Beam Absorption in Recording Media:

The penetration of electrons into a material is determined by the density of the media in which the beam is propagating, regardless of the molecular weight of the material. Hence Figure 9 can be used to determine the minimum thickness of the recording layer needed to achieve complete absorption of the beam. Most metals have a density of approximately  $7 \text{ gm/cm}^3$ , giving a Practical Range of about 17nm for 500V electrons, with zero electron penetration beyond a material thickness of  $R_m (= 1.2R_p)$ , = 10.5nm. Higher velocity electrons will penetrate to an extent slightly greater than linearly, i.e. at twice the energy electrons will penetrate about 2.2 times as far. Typically the media absorption depth should approximate the recorded mark size.

## 9. Data Storage Applications

NS3's primary goal is to establish the viability of the proposed approach and develop technology that avoids the limitations of current data recording technologies, with advanced performance in compact form factors. The developed technology should provide economically affordable high storage capacity, high read/write data rates, and fast access. The technology should be compatible with either removable or embedded media and with erasable or archival media. Products with all of

these characteristics would apply to several large market segments now addressed by numerous current products such as hard disk drives, optical discs including CD-ROM's and smaller discs, floppy discs, and all tape drive systems. Figure 1 shows the expected user capacity for various standard sized platters as a function of recorded mark size, with track spacing twice the mark size and PRML encoded data.

The CNT e-beam technology can be embodied in disk drive designs that fall into two principle categories.

1...Larger media disk sizes such as 120mm diameter (CD sized) using removable media and having capacities in excess of 1 Terabyte. Removable media implies in air media operation and therefore transmission of the e-beam through some air distance. This implies a CNT structure that is sealed in a vacuum tight head with the electrons passing through a semi-permeable membrane to the media. Another implication of in-air operation is the window must be within fifty microns or less of the disk surface for the beam to be adequately transmitted and may require a flying head, depending on the disk vertical run-out. Smaller fly heights permit greater transmission and lower beam spread due to scattering by air molecules. Current magnetic head fly heights are far less a about 10 nm.

2...Smaller disk sizes, 2.5 inches or less using embedded non-removable media. For this design option both the CNT head and media can be sealed in a single vacuum enclosure and an e-beam window is not required enabling smaller mark sizes. This also enables lower beam voltages and with lower disk vertical run-out a vertically fixed head can be used.

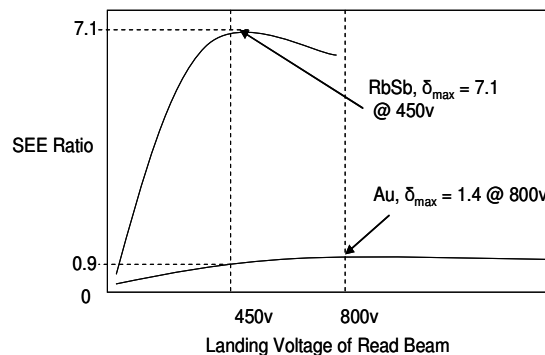
Either design approach is compatible with Read Only Media (ROM), Archival Media, or Erasable Media, depending on the intended application, although the various media require development.

One possible application is low cost mass storage of truly archival media (100+ years), that is removable and robotic compatible. Archival data storage is not viable using magnetic hard disc drives and the only other and currently employed option is magnetic tape. However, magnetic tape is not archival, nor is it cost effective due to the high cost of storing thousands of removable low data density tape cartridges in robotic servers. Further, data access is slow due to long tape wind times and tape is inherently a fragile media. Both issues are aggravated by thinner and longer tape used to increase cartridge capacity. Magnetic tape technology therefore no longer meets the need of capturing and retrieving terabytes of data per day and storing the data in an easily accessible archival database and is rapidly becoming obsolete. It would soon be abandoned except that, unfortunately, today there is no other alternative.

## 10. Media Characteristics

While the ability to record nanoscale marks by e-beam radiation is not in doubt, the read mechanism is less certain but can be based upon prompt emission of secondary electrons upon media irradiation by a read e-beam. Many media options exist as all materials exhibit secondary electron emission (SEE). The ratio of secondary to primary electrons (SEE coefficient,  $\delta$ ) is usually greater than unity and depends on the material and the primary electron energy. There is a specific electron energy that gives a maximum value of  $\delta$  for each material. Initially  $\delta$  increases with the primary electron energy until a maximum value is reached. At higher primary electron energies secondary electrons are generated deeper into the material and are reabsorbed resulting in lower  $\delta$  values.

One possible archival media is a very thin layer of gold deposited on a thin layer of RbSb. The optimum electron energy for reading is about 300-450 volts, at the peak SEE output of the RbSb sub-layer, and for unwritten media the lower gold SEE ratio at this voltage will apply and few electrons will be emitted. Writing is accomplished by melting both layers so the gold is absorbed or mixed into the RbSb layer. On data read, without the gold top layer, the SEE response of the RbSb will dominate and the readout SEE rate will be about 8X greater as shown in **Figure 9**.



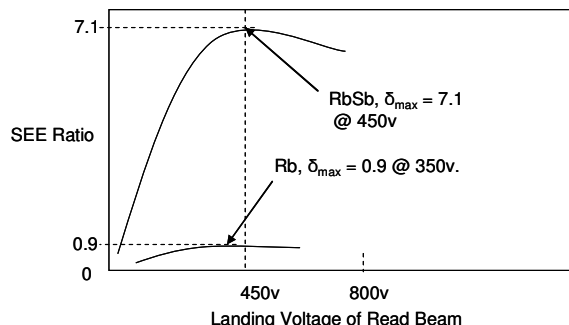
**Figure 9. SEE Response Curves for RbSb / Gold Archival media**

The SEE outputs are 'prompt' and occur picoseconds after e-beam irradiation. Similar media designs using RbSb can be considered using a variety of low  $\delta$  SEE materials; tin, lead, indium, gallium etc.

A similar approach could use a two layer media with Rubidium deposited over Antimony. With an under layer of Antimony (Sb), and a layer of Rubidium (Rb,  $\delta=0.9$ ) on top, the unwritten response would be low, but on melting the layers would mix, and after cooling increase the SEE response to that of RbSb at  $\delta=7.1$ . Control of the initial deposited layer thicknesses

provides the Rb, Sb mix for maximum SEE output shown in **Figure 10**.

In addition to phase change media, more active media using semi-conductor materials can be considered in a variety of media designs. And unlike optical recording, e-beam recording has two beam parameters that can be independently varied, current and voltage, so the optimum electron landing voltage for both write and read functions can be achieved at any current level. The read voltage should therefore be close to that at which the maximum difference in  $\delta$  values is obtained.



**Figure 10. Rb over RbSb Media layers**

In a typical NTD R/W head design an annular detection electrode is located on the head just above the media surface. On reading this electrode will capture the secondary electrons emitted by the media, and will do so more efficiently if it is at a slight positive potential relative to the media.

### 11. Beam Energy Calculations:

For a 100nA beam at 100 volts and 90% window transmission the beam energy exiting the window is  $0.9 \times 100 \times 10^{-9} \times 1,500 = 135 \times 10^{-6}$  Watts. After passing through 50 microns of air ( $T = 82\%$ ) the beam energy will be 100  $\mu$ W. Focusing to 27 nanometers diameter gives a power density of  $1.6 \times 10^7$  watts/cm<sup>2</sup> and a 1.0 nano.sec. pulse duration gives  $1.0 \times 10^{-12}$  Joules/mark. By comparison, the energy calculated to melt a 27nm diameter mark, 50nm thick, layer of Antimony (Sb), of density 7, is calculated at  $1.13 \times 10^{-13}$  Joules.

Data read out is with an e-beam at 30% or less of write power to avoid inadvertent beam tip writing. If the read flux is 30% of the write power at 30nA the electrons emitted from a SEE  $\delta = 7$  material should provide 210 nanoamps of SEE current, about 1300 electrons per nanosecond. These electrons are to be collected by an electron detector surrounding the emission zone and a small voltage between the media and the detector moves them in that direction. An SNR of 10 with 210nA of SEE output typical should be obtained with a silicon diode electron detector preamplifier noise current of about 0.5pa/sq.rt.Hz, or 15.8nA at 1GHz.

A detector bias of 200v relative to the media accelerates the electrons which arrive at the detector with sufficient energy to give an internal noiseless gain of 12X, increasing the signal/noise current ratio to 120. However, with the number of emitted and collected electrons at about 1300, and less than 200 electrons in the read beam, statistical variations will prove the limiting SNR factor. Another NHA benefit is its ability to electronically steer the e-beam. High bandwidth electronic beam steering enables a two stage tracking servo facilitating track following at the nanoscale. Electronic steering also allows the read beam to move across multiple tracks without moving the actuator arm.

### 12. A Preliminary Design

The initial design approach employs a rotating disk with an e-beam sensitive media layer and a CNT based read/write head assembly 0.5mm in diameter, 1mm long, mounted on an actuator arm. The entire CNT/electrodes structure is located in a vacuum housing with the CNT at one end and the e-beam exiting the structure through a semi-permeable membrane at the other. The multi-walled CNT of any chirality has a length of about 800nm and is nominally 30nm in diameter. A first gating aperture electrode is located concentric to and 1 $\mu$ m from the CNT tip and is nominally at a 50 volt potential to the CNT, providing a beam current of 0.1 micro amps, with over 1 $\mu$ A available. A second concentric focusing electrode is distant 1  $\mu$ m from the gating electrode and at the CNT potential. A window 20 nm thick is located as a seal at the end of the vacuum enclosure and 1mm from the CNT. An aperture electrode is located inside the window at a positive accelerating voltage of 1.5KV. The focusing voltage is adjusted so the e-beam is brought to a slow focus 10-20 microns from the window exterior with the media 15microns from the head structure.

### 13. Future Performance Growth:

The burden of future growth in NanoDisk performance lies mostly with the media. Beam size can be reduced by apertures within the NHA or by CNT tip narrowing, potentially achieving mark sizes down to 5nm or less and providing capacities up to 10Tbits on a 120mm disc.

Any efficient data storage system has to strike a balance between data capacity, access bandwidth, and seek time. This is particularly true where multiple users are trying to simultaneously access the same media volume. Rather than pursue greater disk capacity requiring mark sizes below 5 nm, perhaps a better direction for future development will be nano head designs with multiple parallel CNTs to substantially increase data I/O rates, providing a better balance of I/O bandwidth/seek-time/capacity.